

37032282

Silicone LED Strip

Technical Datasheet

Original Product

I. Products Overview

The Original 4*10mm Neoflex LED Strip is a flexible, high-performance lighting solution designed for versatile applications. With a compact 4mm width and 10mm thickness, this strip is ideal for installations where space is limited, such as tight corners, narrow profiles, or decorative lighting. The Neoflex LED strip offers a uniform and bright light output, providing both functionality and aesthetic appeal for various lighting projects, including under-cabinet, shelf, and accent lighting. Its flexibility allows it to bend and conform to different shapes, making it a highly adaptable solution for both commercial and residential environments.

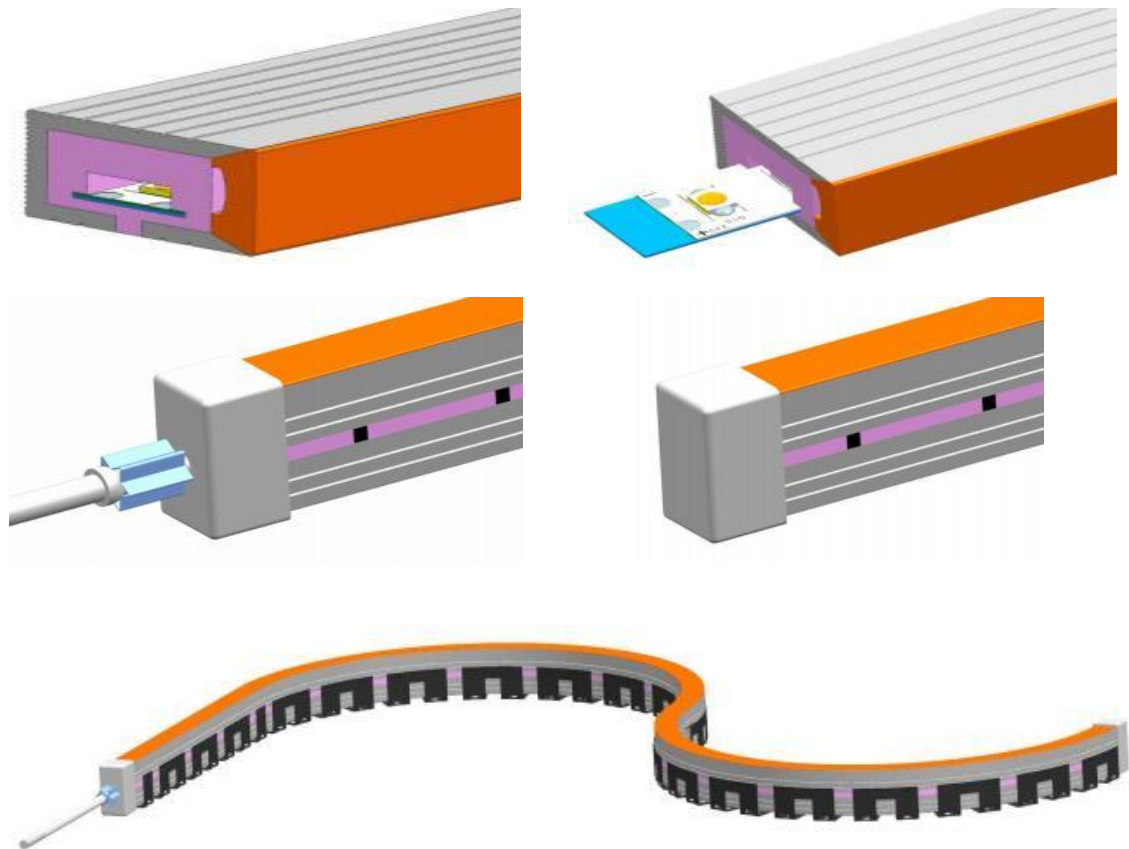

II. Features

The Original 4*10mm Neoflex LED Strip is engineered to offer superior performance and durability, making it ideal for a wide range of applications in both residential and commercial environments.

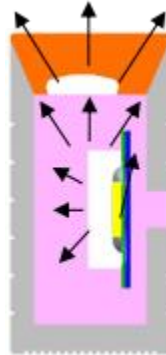

- **Professional Structural Design:**
The strip ensures uniform light emission with no visible spots, providing soft light and excellent color temperature consistency, perfect for achieving a polished and consistent lighting effect.
- **Food-Grade Silicone Material:**
Crafted from high-quality silicone, it resists yellowing, high and low temperatures, making it suitable for both indoor and outdoor use in harsh environments.
- **Corrosion-Resistant:**
Built to withstand weak acids, alkalis, and salts, the strip is highly durable and can function in extremely challenging environments.
- **Waterproof Performance:**
With an IP67 waterproof rating, this LED strip offers reliable protection against water and moisture, ensuring longevity in wet or humid conditions.
- **Exceptional Flexibility:**
The Neoflex LED strip is designed to be resistant to bending and pulling, offering excellent shape retention and making it easy to install and ship.
- **Reinforced Base Plate:**
Featuring a flexural and tensile-resistant base plate, the strip is strong and durable, capable of withstanding physical stress.
- **Precise Cutting Points:**
The highly transparent cutting position ensures easy and accurate cutting to any required length, offering customizable flexibility for your lighting needs.
- **Co-Extruded Construction:**
The light strip and base plate are co-extruded in one piece, creating a solid, reliable product with enhanced durability. This combination of features makes the Original 4*10mm Neoflex LED Strip a versatile, robust, and efficient lighting solution suitable for a variety of demanding applications.

III. Dimensions & Structures

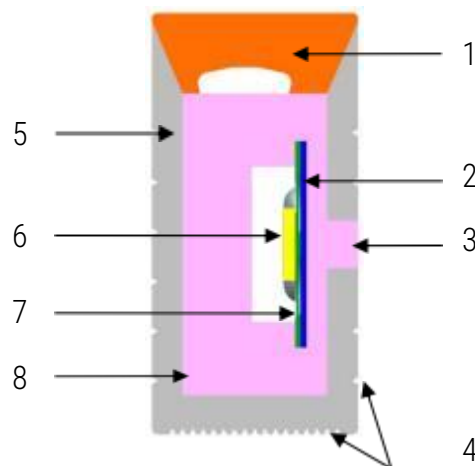
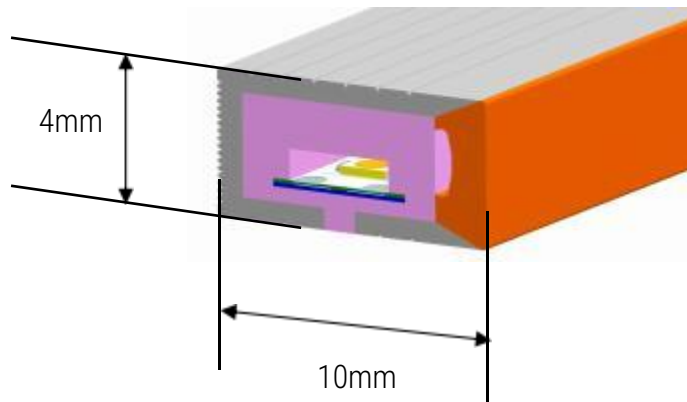









No.	Structure name
1	Luminous surface
2	Anti-bending, anti-tensile, high and low temperature resistant baseboard
3	High-transparency cropping window
4	Sawtooth (Increase friction during installation)
5	Shading layer
6	LED chip
7	Flexible PCB
8	Highly transparent core

IV. Parameters

Item	Data
Material:	Silicone
Board width(mm):	5mm
Voltage(V):	DC24V
Power(w/m):	10W
Color temperature(K):	2700K~6500K±100
Number of lamp beads:	100 lamps/m, 1 LED/cut
CRI(RA)	90
Cross-section size Width x height (mm)	04X10
Operating temperature(C °)	-20~50 °C
Waterproof rating (IP)	IP67
Fire rating:	V1
Impact level test:	Shatter resistance grade IK04
Warranty period:	2 years

V. Mounting accessories

	
Left endcap (wire goes through)	Right endcap (wire goes through)
	
Straight endcap (wire goes through)	90 degree endcap (wire goes through)
	
Endcap (no wire goes through)	Installation clip (one piece)

	Stainless steel round hoop
	Straight clip strap (one meter per set)
	S-shaped clip strap (one meter per set)

Note: The maximum length of the straight clip tape and S-shaped clip tape can be customized is 50 meters / roll.

VI. Installation

A. How to cut the LED strip.

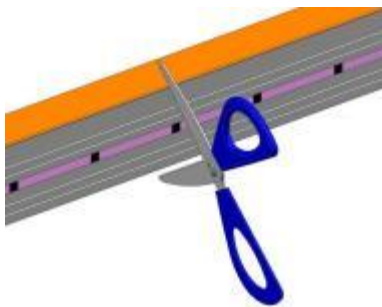

Cut at the black dot mark position in the high-transparency clipping window.

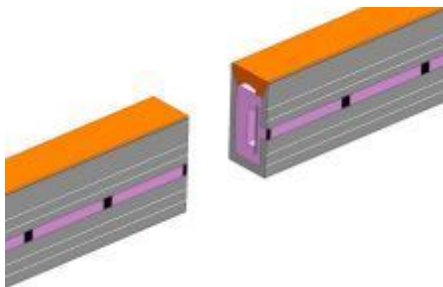

After cutting

B. How to install the endcaps

B1. Select the appropriate endcap according to actual needs, prepare the power cord and stainless steel round hoop.

- Please refer Section V (Mounting accessories).

B2.1 Put the stainless steel hoop onto the power cord from the welding end.

B2.2 Insert the 6mm power cable into the outlet plug in the direction of the arrow.



B3. Solder the power cord to the PCB board with the red positive pole and the black negative pole, or solder according to the line sequence specified by the product requirements.

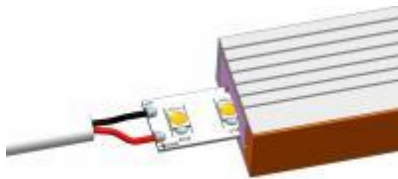

B4. Apply glue around the endcap of the light strip, fill the cavity outside the welding wire with glue, and install the plug in the direction of the arrow.

Then fill the outlet hole with glue. After completion, wipe off the excess glue on the plug and outlet. Use the same method to apply glue and install the tail endcap (non-wire plug) on the other end of the light strip.

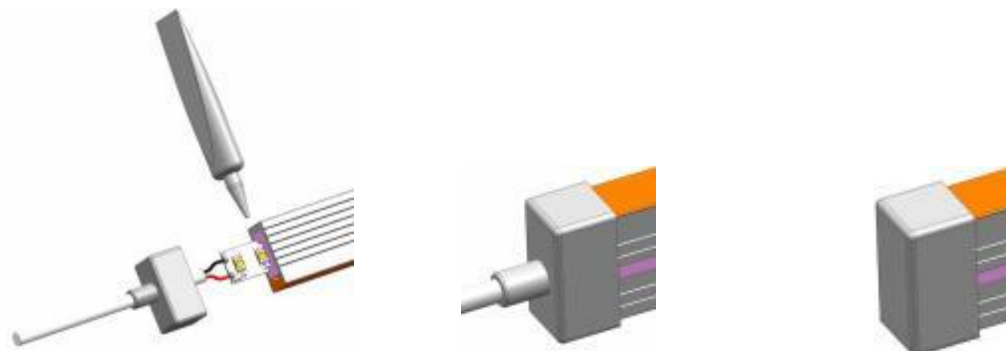

B5. After installing the endcap, let it stand for 15-20 minutes before moving it. After 1-2 hours, put the stainless steel hoop into the stamping area of the plug. Waiting for stamping, and waiting for packaging after stamping.

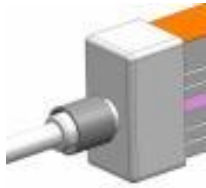

Waiting for stamping

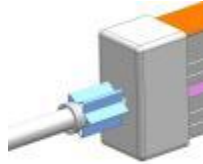

After stamping

C. How to install the Clip.

C1. Select appropriate clips according to the actual installation environment of the light strip and prepare the screws .

- Please refer Section V (Mounting accessories).

C2. Adjust the buckle to the appropriate position first and fix it with M3 screws.

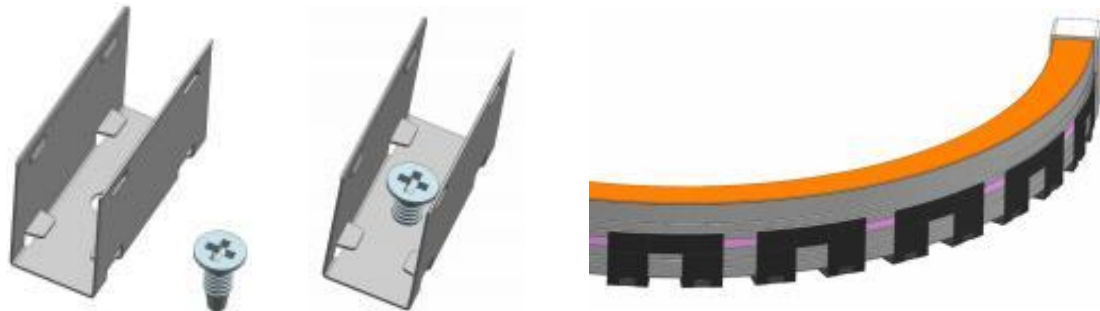

C3. When installing the light strip, place the light strip into the buckle with the luminous side facing outwards.

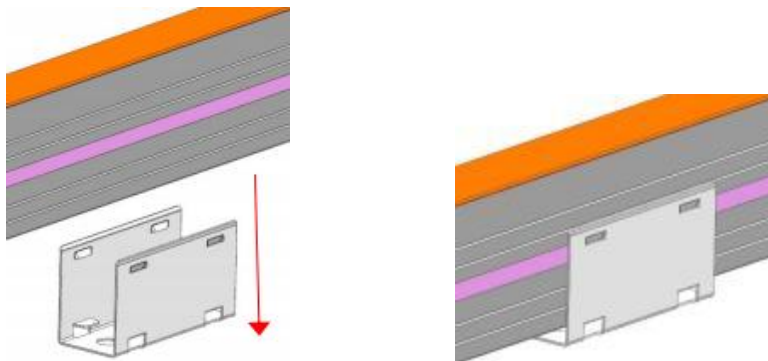

VII. Precautions



This product uses low voltage DC power supply and must use an AC-to-DC LED Driver to convert AC power to DC power before use! It is strictly forbidden to connect the LED light strip directly to AC 110V or AC 220V mains voltage connection, otherwise the LED strip will be damaged, and may cause safety accidents !

Please read the product specification carefully before using this product, and ask professionals to install it to ensure safe use.

When installing the light strip, please note that not all directions can be bent. For the shape, size and direction of the bend, please follow the illustrations below to avoid damaging the light strip.

How to bend correctly:

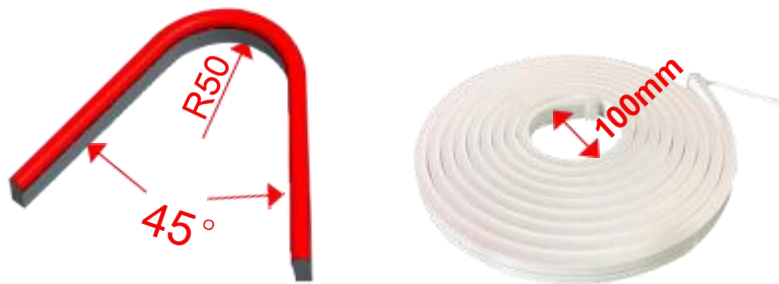

The light strip is bent in half with the luminous side facing upwards (As shown in the figure). Minimum bending radius is 50 mm, minimum bending angle is 45 °.

For 5 meters packed roll, package (reel) should be with shiny side facing up, minimum bending diameter is 100 mm.

Note: If there is a longer finished product, inner diameter bending radius should be larger, to avoid breaking the bare plate inside the neon tube.

Wrong bend



The light-emitting side faces upwards (as shown in the picture). Please do not bend the light strip downwards . To avoid damage Light bar.

The luminous side should face upwards (as shown in the picture). Please do not bend light bar upward, to avoid damaging the light strip.

Note: PCB board inside the neon tube is extruded from the side (PCB board and the shading layers are parallel and the light is side-emitting) and can only be bent sideways.



As shown in the figure :

Please do not twist the light bar too hard to avoid damaging the light strip. Do not pull the wire too hard. Do not puncture the colloid of light strip with sharp objects.

VIII. Light strip cleaning

During installation and use, the light strip may get dirty. You can use a cotton cloth , dip it in clean water or sprinkle it with water, and gently wipe it. For dirty places, just clean them, do not rub too hard or for too long.